

WHAT YOU HAVE TO BELIEVE TO BE AN ATHEIST!

The following closely follows a presentation made at Memorial (Houston) on 7/10/13:

On December 27, 1831 a young 22 year old Cambridge graduate student named Charles Darwin boarded the H.M.S. Beagle for a geological tour of 5 years. One of the places he visited was the Galapagos Islands, 500 miles off the west coast of Ecuador, literally on the equator. If you fly east to Lafayette, LA and then fly due south to the Equator, you will be at the Galapagos Islands. He observed that Finches on islands with mostly nuts as food tended to have smaller beaks than the Finches on islands with mostly soft fruit as food. Based on this, 28 years later in 1859 he published the book ON THE ORIGIN OF SPECIES BY MEANS OF NATURAL SELECTION which has become the Bible for atheistic evolutionists. The variation in beak size was a minor variation within a species and in no way supported the conclusion that natural selection explained the origin of species. It was sort of like saying I can throw a baseball, therefore I can hit the Moon with a baseball.

However, since then, to a large extent Christianity has been in a defensive retreat from a massive government funded promotion of atheistic evolution. As a measure of how far we have retreated, 1811 while a student at Oxford, the English poet Percy Shelley composed a tract titled "The Necessity of Atheism" and it got him expelled. Today in a state university if he composed a tract titled "The Necessity of God", it would probably get him expelled.

To some extent as religion had gone over-board in the middle ages in their teachings and control, as a result, anything which would react against this would tend to receive favorable status treatment. Atheistic evolution has benefited from this.

I have been running an informal survey recently. I have asked "Do you believe the scientific proofs of evolution which have been published in the media lately?". The typical answer has been "No I believe in God instead." It was a trick question. If your child or grandchild heard the question and your answer what he/she heard was that you did not question but that there are recent proofs of evolution, but that you simply ignored them in favor of God. When he/she is confronted by an atheistic teacher at school, you have put him/her in the position saying we ignore the scientific proofs in favor of a God we cannot prove. He/she is set up to fail.





WHAT YOU HAVE TO BELIEVE TO BE AN ATHEIST! , P. 2

The reason I said it was a trick question was that there are no proofs of evolution printed in the media. There are theories and guesses as to what might have happened which are given favorable treatment status in the liberal media and stated as facts. They are not facts. They are just the latest unproven theories.

For that reason, the lesson tonight is not for you, as no one here tonight is likely to become an atheist and few are likely to even engage an atheist in a discussion. This lesson is for your child or grandchild, and to help you help him or her. This will be their battlefield.

MY QUALIFICATIONS

In my qualifications to make this talk, I need to confess I do not have a degree in biology, geology, zoology or any other "ology", or even a degree the Bible. I am a mechanical engineer. However, as I see the creations of the heavens and the earth as an extremely inventive process. As I am a certified inventor more than 100 US patents at the present time. this is what I do.

Secondly, I have been passing this business card out for the past 20 years to every atheist I can find. After 20 years, I still have my \$100. Whereas it is not everyone's job to be prepared on this subject, I take it as my job. I am going to summarize information tonight for you so that you will know that someone is ready to answer the questions any time or any place. It will be fast and detailed, so that you will know that the information is available. You don't have to try to memorize it, what I am saying

tonight will be the lead article in the July issue of the Christian Array E-Magazine and will be posted on the website "thearray.org" for you to review at leisure and print out if you desire. If you do not receive the E-Magazine, give me your e-mail address and I will send it to you monthly.

I am going to criticize what are some conventional scientific conclusions; however, you need to know that there is no conflict between God and science. God created science and so God and science are in perfect harmony. There is conflict between scientists and religionists, not God and science.

IMPOSSIBLE FOR EVOLUTION

We will give you \$100 if you can give us a single reason why atheistic evolution is a better explanation for our existence than Jehovah.

We will give you \$100 if we cannot give you 12 reasons why atheistic evolution is impossible as an explanation for our existence.

We will discuss any time, any place, any forum.

www.TheArray.org

THE ARRAY

Benton F. Baugh, PhD, P.E.
E-mail: bbaugh@thearray.org

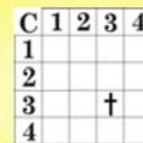

DEFINITIONS:

We will be discussing what an atheist is advocating by accepting the title. Some atheist have little idea what they are advocating, frequently they just don't believe in the God they see in contemporary religion. Frankly as you have seen some of the abuses of the churches in the middle ages and even today, plus the charlatans profiting off religion today, it is easy to understand why some people can be put off by religion.

WHAT YOU HAVE TO BELIEVE TO BE AN ATHEIST! , P. 3

There are only two choices offered for the creation of the heavens and the earth and all things included.

Atheism presumes to explain all things in terms of natural laws. Functionally atheism and evolution go hand and hand as a single belief.

Theism contends that some things did not happen according to natural laws, or in other words were supernatural events. This is closely related to the contemporary term "intelligent design".

With respect to Intelligent Design, what is the measure of Intelligent Design that separates innovations from what would simply happen by chance events or mutations?



David Penninger gave us a great example 2 weeks ago. The three rocks stacked together as shown for a trail marker would universally be considered as a sign of intelligence. Just file that away for reference right now.

One more tedious point we need to cover before we get into the lesson. The **first law of thermodynamics** indicates that you can't create something from nothing. The **second law**

of thermodynamics teaches that you cannot have perpetual motion or that all systems run down. If you have a system that violates either of these laws, you do not have a natural system but rather you have a supernatural system. Again, file that away for reference right now.

Now down to business:

WHAT YOU HAVE TO BELIEVE TO BE AN ATHEIST EVOLUTIONIST!!!

NO INTELLIGENT DESIGN

You must believe all things happened by the laws of nature. Shouldn't be hard for an atheist to agree with this statement.



THERE WAS NOTHING, THEN THERE WAS SOMETHING

You must believe this happened according to the laws of nature, without the assistance of an Intelligent Designer or a God. So far so good. This is unproven and unprovable. It is important to note that as this cannot be verified by scientific experiments, this is a belief, not a fact.

THE BIG BANG WAS EXEMPT FROM THE LAWS OF NATURE

If the Big Bang created something from nothing, it violates the first law of thermodynamics. If matter existed forever and was a repeating cyclic Big Bang, it violates the second law of thermodynamics.

WHAT YOU HAVE TO BELIEVE TO BE AN ATHEIST! , P. 4

ATHEISM IS NOT A RELIGION

In either case you must believe in a supernatural event (or a miracle) to get your atheism kicked off. You must accept a supernatural event and claim it as natural (or put your head in the sand).

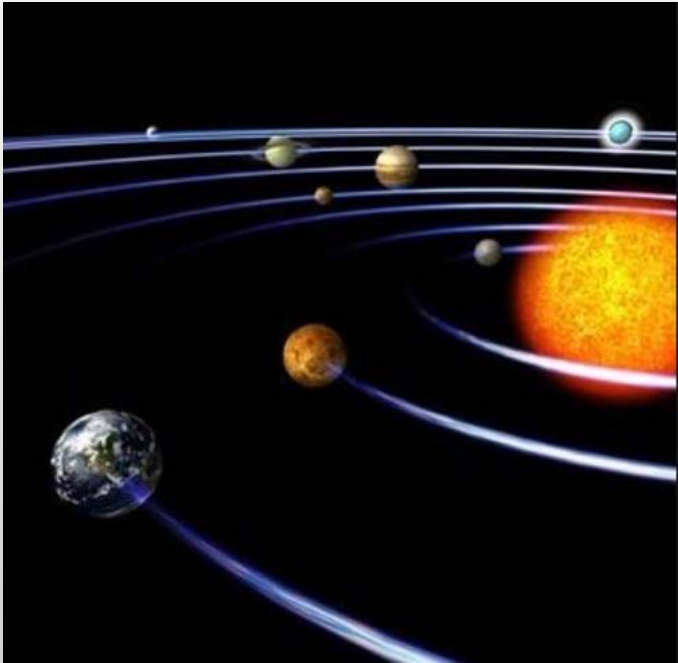

ROTATING, ORBITING PLANETS

Within 3 minutes of when the Big Bang was a point smaller than a baseball 13.7 billion years ago the universe had cooled to a manageable 1 billion degrees. 380,000 years later the universe cooled enough to form hydrogen atoms. 200 million years later stars began to coalesce. This explosion of pure Homogenous energy from the singularity produced:

1. Galaxies in rotation
2. Stars such as our Sun which is a continuous thermonuclear reaction.
3. Planets such as the Earth which perpetually rotate the Sun and have a convenient rotation to maintain a heat balance all around.
4. Moons, such as ours, in perfect orbit around planets such as our earth.

5. A wide range of chemical elements such as gold and diamonds, many of which our scientific labs cannot duplicate in the best of conditions.

You must believe this massive explosion produced such incredible order. We actually have a small example of the Big Bang.



On August 6, 1945 at 8:45 a.m. the Boeing B29 Superfortress Enola Gay dropped the atomic bomb "Little Boy" from an altitude of 31,000 ft.

WHAT YOU HAVE TO BELIEVE TO BE AN ATHEIST! , P. 5

It fell for 44 seconds to the altitude of 1968 feet above the city of Hiroshima and exploded. The fireball was several million degrees in temperature and when the heat wave of 7200 deg. F. it reached the ground. Everything was devastated and 66,000 people were killed. It is interesting that even the Atheistic Evolutionists saw only death and destruction in the atomic bombs. None of them were searching the ground for gold, diamonds or orbiting planets.

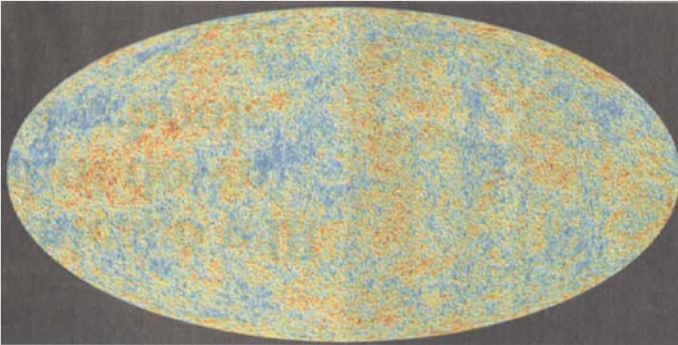

THE BIG BANG PRODUCED A FLAT UNIVERSE

Whereas you would think that an explosion would produce a round universe, sort of like a ping pong ball, the universe is flat. It is like God spread it out as a large canvas to work on. Notice no one says "right there is where the Big Bang happened. If there was any truth to it at all and it happened like the latest graphic I have received as seen on your right. the Big Bang would have happened near the center. The gravitational pull on the slow moving close items would have caused them to fall back to the center leaving a relatively vacant area near the center. Their best information says they are wrong.



LIFE ELECTROCUTED INTO EXISTENCE:

Something akin to life with DNA was created when lightning struck a primordial brew. If you find a scientist who says that with a straight face, offer to give him all the chemicals appropriately arranged and simply ask him to bring it to life. If he doubts that you can do it and accepts your challenge, scratch your fingernails across your arm and give him some dead skin cells. With all their technology bought with your tax dollars, they cannot bring a skin cell back to life, so they have no business saying that lightening did in some primordial brew. But if you are an atheist, you must believe it.

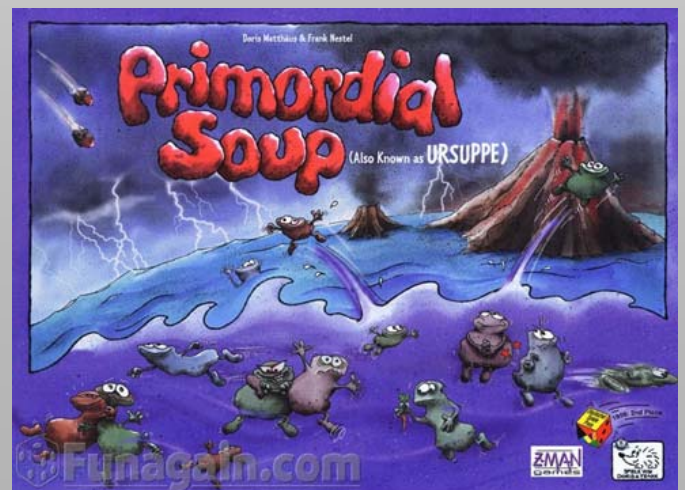

WHAT YOU HAVE TO BELIEVE TO BE AN ATHEIST! , P. 6

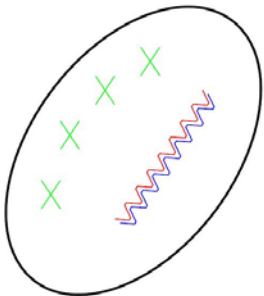

REPRODUCE
GET FOOD (MOVE)
GET OXYGEN
BURN FOOD
DISPOSE OF WASTE

LIGHTNING CAUSED SUSTAINABLE LIFE:

Presuming a cell of life was created, it had to survive. Surviving meant that it had to get food, burn food for energy, and get rid of wastes at a minimum. If you believe getting electrocuted will create DNA, believing this should not be much of a problem. It is important to note that the IQ of the cell is zero. It is unproven and unprovable that this happened.

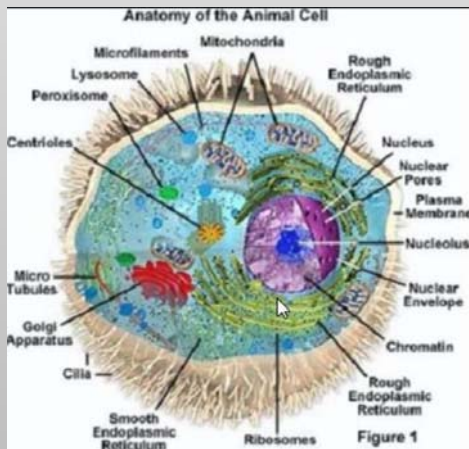

THE FIRST CELL HAD TO REPRODUCE:

It does little if a cell is electrocuted into existence if it then simply dies. The first cell not only has to come to life, but it must come to life complex enough to reproduce. DNA reproduction is a part of cell reproduction. Inside the nucleus of each cell which is so small you cannot see it, is a double helix of DNA which is 6' long. It is described as being a twisted pair of

microphone wires filling an auditorium which become untwisted and separate. A key point of reproduction is this DNA untwisting and separating. This is not a one in a million chance. If you believe in atheistic evolution it had to happen the first time.

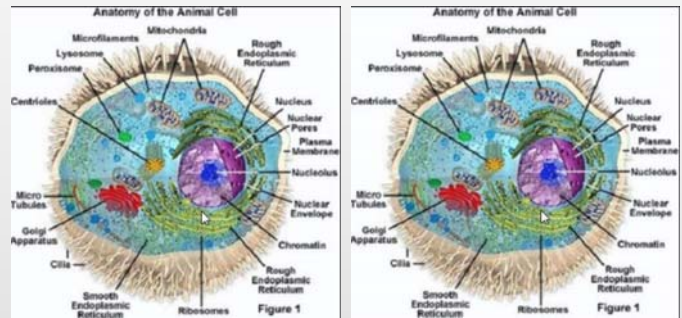

DEAD

ALIVE

DEAD OR ALIVE:

Religionists get to believe that God breathed life into inanimate matter to make it "alive". You don't get to do that. You must believe that there is nothing different in being dead and being alive. When you die you have the same chemical make-up, dead simply equals alive, except that you are not. You have to have faith that someday scientists will figure out the difference.

YOU MUST BELIEVE THE FIRST CELL CAN FIND FOOD:

After your first live thing that the lightning struck reproduces eats the food in the current location or is simply washed to it, it must find more food or die. It has no smell, sight, hearing, taste, or touch, but atheists must believe it can find food. It doesn't have a million years to do it, it must find food now. It cannot be overemphasized that this ability to develop the means to locate the food right now is delegated to a cell which has an IQ of zero. Imagine your IQ is zero and you had never even heard of sight, smell, hearing, touch or taste. How would you find food?

WHAT YOU HAVE TO BELIEVE TO BE AN ATHEIST!, P. 7

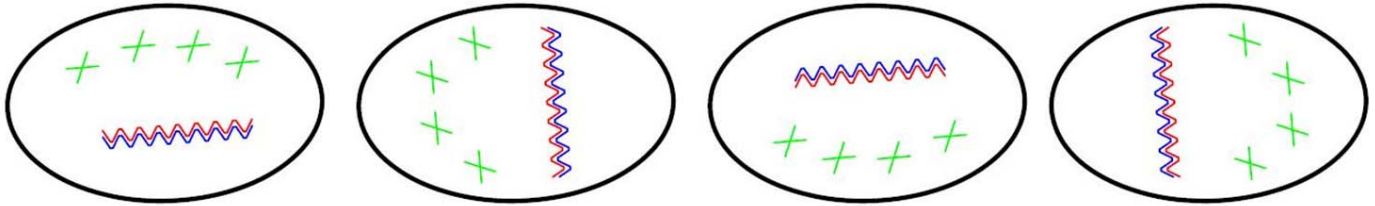

YOUR FIRST CELL MUST GO GET THE FOOD:

After your zero IQ cell determines where the food is, it has to get to it. It has no arms, legs, or fins, it is a single cell. To help you out, we are going to suggest that the cell learns how to do the “blob roll” and goes and gets food so we can continue.

To be an atheist you must believe that your zero IQ cell developed the concepts of finding food and to going get the food, invent a way to accomplish these concepts, and to implement these concepts in a single generation or it dies.

Up to this point the cell has only been concerned with itself, or after the splitting, each of the split cells were only concerned with themselves.

YOUR CELL CAN JOIN WITH OTHERS TO MAKE A MUSCLE:

Joining together in a 2 cell thick tissue is not particularly difficult. However, when you get to 3 thick, the middle cells starve to death unless you develop some form of circulation. Circulation requires some pumping such as a heart or at least some cells expanding and shrinking in a coordinated fashion. You must believe your cells can do this without a leader. Then it has to move to find food – a multi-cell blob roll?

Some cells expand and other cells contract to do circulation pumping can directly benefits the cells doing the expanding and contracting as they get fed by the process, so you can imagine how our zero IQ cells might figure out how to do this.

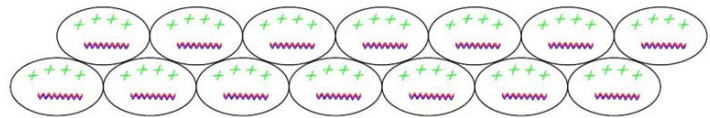

WHEN THE BLOB BECOMES 2 LAYERS, ALL CAN EAT

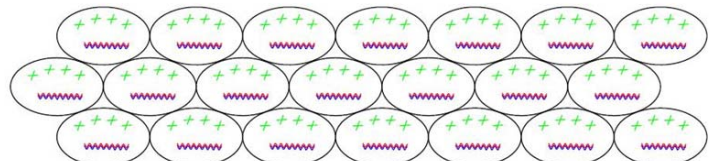

WHEN THE BLOB BECOMES 3 LAYERS, THE MIDDLE LAYER STARVES

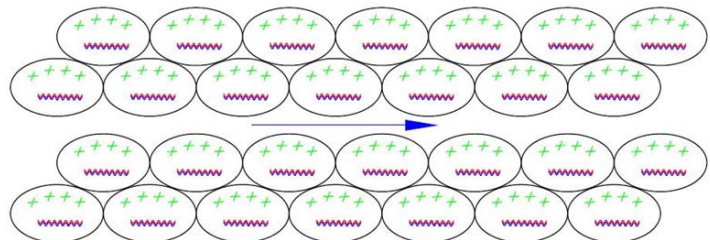

CIRCULATION MUST BE ESTABLISHED TO SUPPORT MORE THAN 2 LAYERS OF CELLS IN A BLOB

But how about if a cell needs to learn to do something and has no idea why and is of no direct benefit to itself. This would be the development of a **blind attribute**.

WHAT YOU HAVE TO BELIEVE TO BE AN ATHEIST!, P. 8

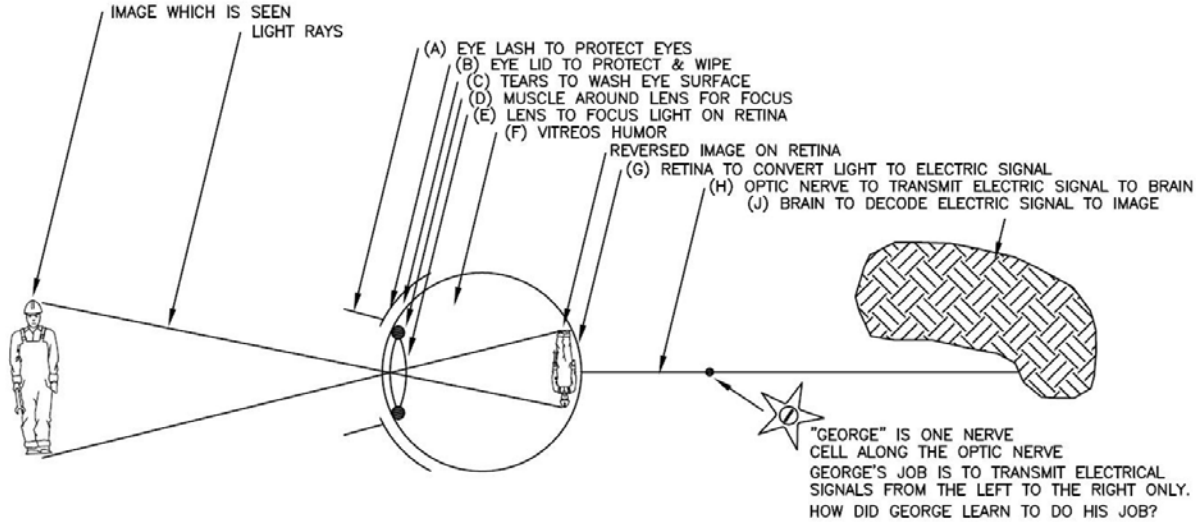

decode the electric signals. When all that is said and done, science has no idea how the signal is decoded so that you recognize a man in front of the eye.

DEVELOPMENT OF BLIND ATTRIBUTES:

This graphic shows such a case. Ignore the myriad of spectacular items it takes to make vision for the moment and focus solely on the one nerve cell "George". George's job is to take an electrical signal from the left and faithfully transmit it to the right. George has no idea why he is doing it. In a remote sense, it assists George in getting fed, but he has no idea of that. If he does not do it, the person is absolutely blind. Also, remember George's IQ is zero. As an atheist you must believe that George with his zero IQ is smart enough to learn to properly and faithfully transmit the electric signal. Every George along the way also has to do it right, or the person is blind.

YOU HAVE TO BELIEVE ALL THIS HAPPENED BY CHANCE

In the same graphic with George still identified. It identifies a few of the things that a blind cell being must invent before it can see. A lens with a muscle around it so it can focus. A clear vitreous humor in the middle of the eyeball, a retina on the back to convert the focused light into electric signals, an optic nerve to carry the signals to the brain, and a brain to

Across the bottom you see a tongue which invents the concept of taste and then implements it, an ear which invents the concept of hearing and then implements it, skin which invents the concept of temperature touch and then implements it, and a nose which invents the concept of smell and then implements it. You must believe that these cells invented these spectacular concepts even though they had a zero IQ.

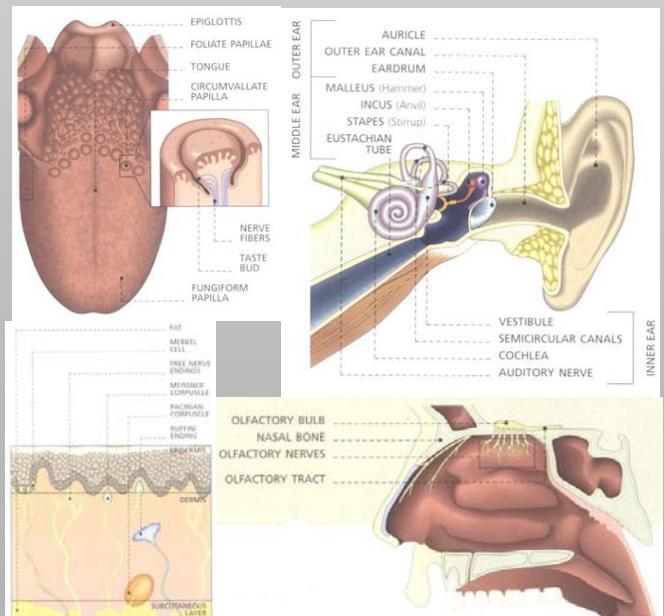

WHAT YOU HAVE TO BELIEVE TO BE AN ATHEIST!, P. 9

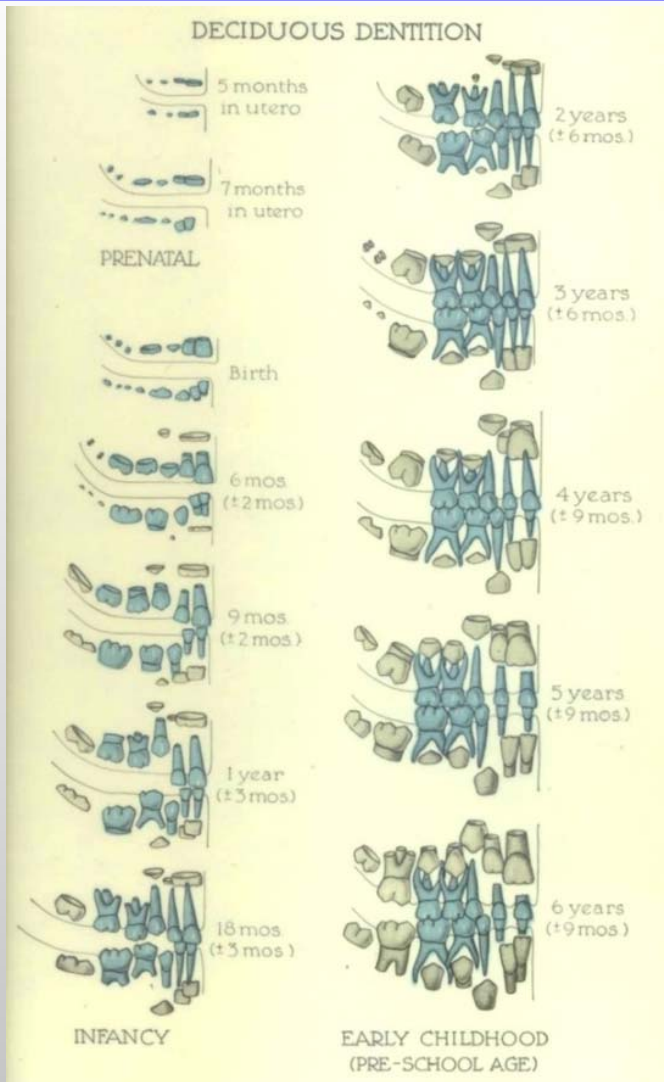

TEETH AND BONES DO NOT REFLECT INTELLIGENT DESIGN

You have to believe that the incredibly complex design work of the spinal column is simply accidental mutations. You would believe the same with teeth except baby teeth for a really interesting thing. Baby teeth are actually almost as long as adult teeth rather than the short things we see fall out. As the adult teeth grow below the baby teeth, the baby teeth dissolve in a process called “resorption of roots” so they can easily fall out. This is most visual



in the row of teeth on the right side of the graphic.

STRIPES ON FEATHERS ARE NOT INTELLIGENT DESIGN

Birds without stripes reproduce and survive just like birds with stripes so there is no survival of the fittest justification. A horizontal stripe means that on each successive barb (below) extending out from the center shaft of the feather, the distance to the color change needs to be closely programmed. It takes a lot of programming to put a stripe on a feather. The peacocks show have massive stripping programming. There is only one reason for there to be stripes on these birds – so that you will know there is a God

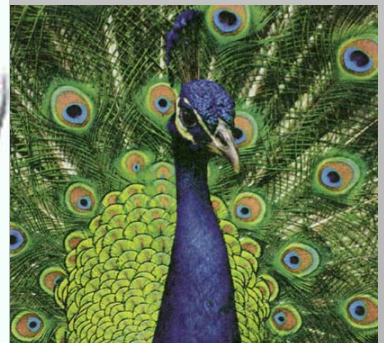

WHAT YOU HAVE TO BELIEVE TO BE AN ATHEIST! , P. 10

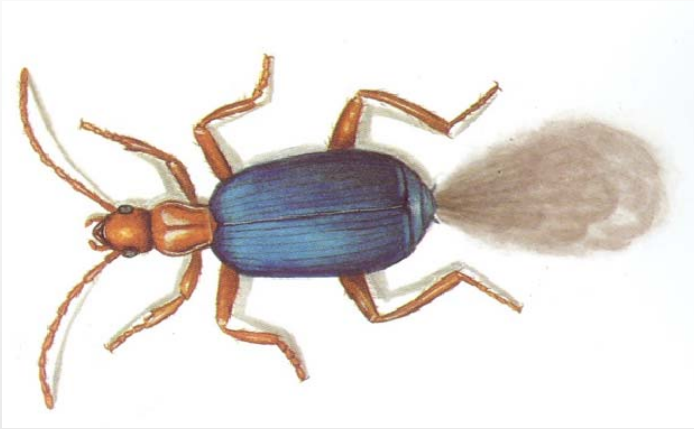

YOU HAVE TO BELIEVE BOMBARDIER BEETLES DID HIND-SIGHT R&D!

The Bombardier Beetles have hydrogen peroxide and hydrogen quinone in chambers in their rear end and spray it out at 500 pulses a second. When the spray mixes together it heats to 212 deg. F. as a defense. You must believe that the Bombardier Beetle developed this characteristic by trial and error, and lived to try again.

If you mix in some of God's own phosphorus which auto-ignites at room temperature and you have the Biblical description of Leviathan in Job 42:1-34.

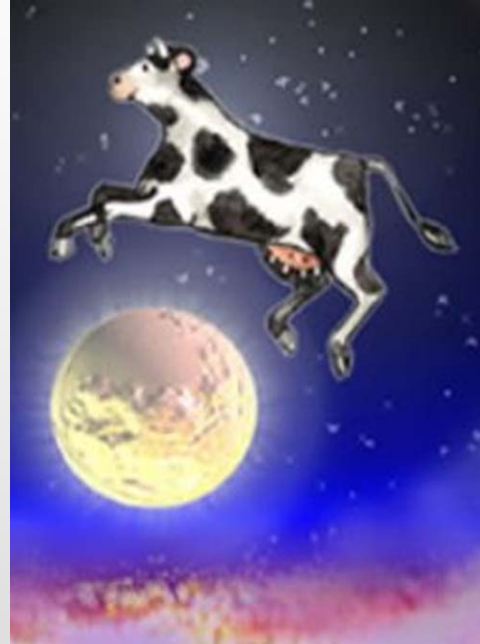

YOU MUST BELIEVE PROBABILITY + TIME IS THE MAGIC ELIXIR

If you assign a 1 in one trillion probability to anything and you believe in billions of years, a thousand events a year for a billion years is a trillion chances. Viola – anything can happen, and further more it can happen on the first chance. Its like buying a lottery ticket with a 1 in 1 million chance to win. You don't have to buy 1 million of them to win. You buy because you might win on the first ticket. This is why we need to be cautious about accepting someone's estimation of long odds on a atheistic mutation process working.

In spite of English nursery rhymes like "Hey diddle diddle, the cat and the fiddle, the Cow jumped over the moon" some things can't happen. Although a cow can jump, there is not a 1 in 1 trillion chance that the cow will jump over the moon. It simply cannot happen, it is impossible. You cannot assign a probability to impossible.

THE CHRISTIAN ARRAY

AN E-MAGAZINE DEDICATED TO SUSTAINED SCRIPTURAL CHURCH GROWTH IN OUR GENERATION

C	1	2	3	4
1				
2				
3				
4				

WHAT YOU HAVE TO BELIEVE TO BE AN ATHEIST!, P. 11



GRAND CANYON WAS CUT BY THE COLORADO RIVER

You must believe one of the great icons of the age of the earth. That the little bitty Colorado river which you have difficulty in seeing in the graphic cut the 10 mile wide Grand Canyon in spite of having to flow uphill 3700' from Paige Arizona and only cut the ground 20' deep downstream at Yuma, Arizona (seen below).

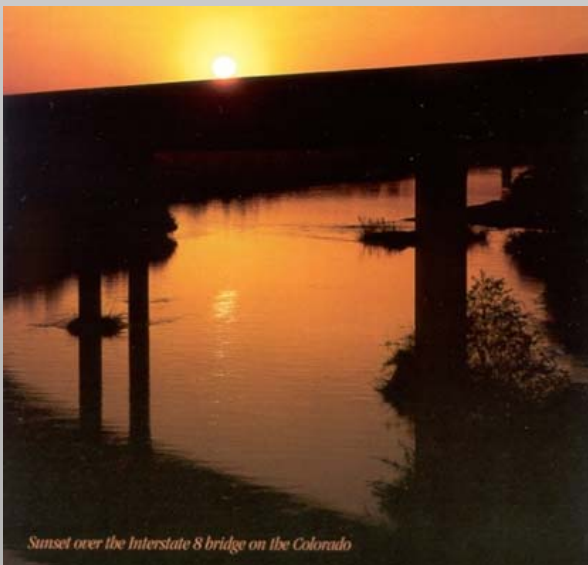

Sunset over the Interstate 8 bridge on the Colorado

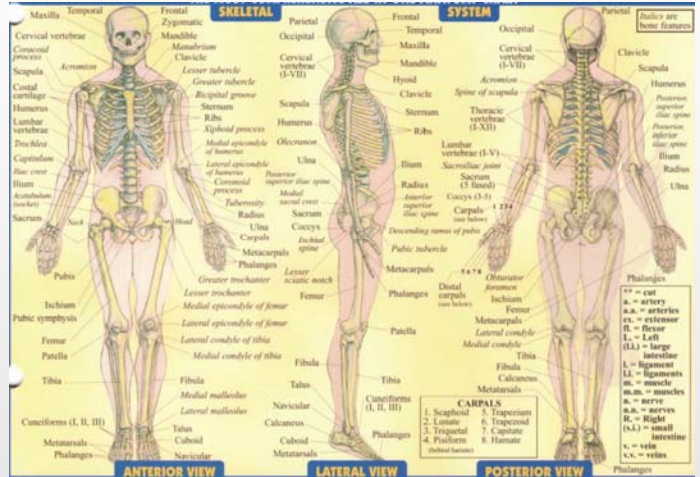

YOU HAVE TO BELIEVE YOUR SKELETAL SYSTEM WAS NOT DESIGNED

If you can look at that and say with a straight face that it is merely the product of chance mutations, I don't know what to say to you.

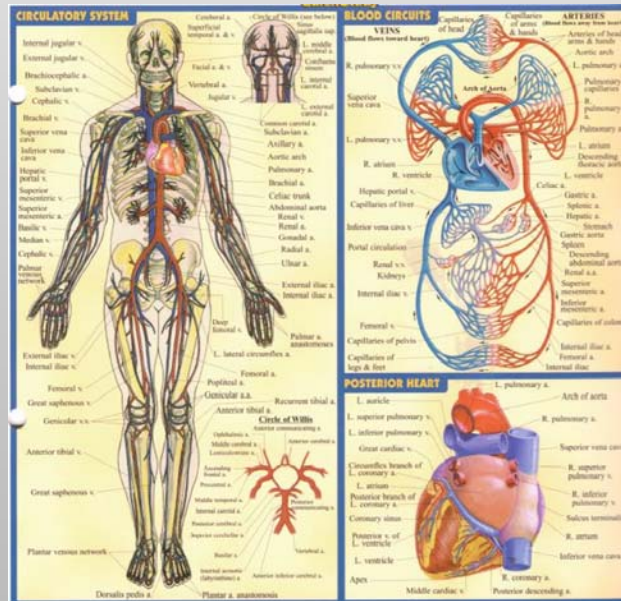

YOU HAVE TO BELIEVE YOUR BLOOD SYSTEM WAS NOT DESIGNED

Again, well beyond the purview of chance mutations, the attached graphic merely shows the freeways. Remember that each cell must be serviced and a massive capillary system does that.

WHAT YOU HAVE TO BELIEVE TO BE AN ATHEIST! , P. 12

A FEW MORE THINGS TO HAPPEN BY CHANCE

Eggs
Flying
Balance
Coagulation
Cuttlefish
Chameleons
Squid luminous system
Aestivation
Flies landing on the ceiling
Wind propagation of seeds (seeds as light as air)

Each of these have been discussed in previous issues of this E-Magazine as "IMPOSSIBLE FOR EVOLUTION!".

CONCLUSION

No one disagrees that 3 rocks stacked on top of each other to mark a trail is a sign of intelligent design. That makes a good measure of what intelligent design is at a minimum.

All you have to do to be a good atheist is to believe that all that has gone before in this presentation shows less intelligent design than 3 rocks stacked on top of each other.

If we say that atheist are believing in impossible things, their response will be to frequently say "we do the same thing for God, so what's the difference?".

The common understanding is that we both recognize supernatural events have occurred.

The difference is that the atheist rationalizes that the supernatural events happened thru natural processes while the theist recognizes that there has to be a supernatural cause for a supernatural event. That supernatural cause is God.

MY FRIEND THE ATHEIST!

I have a highly intelligent close atheist friend and have pressed him on these matters. He has no refutation for these items and his response is "Aren't we lucky!"

His other response is that he refuses to debate the subject with me because he is afraid he might win. He wants to associate with Christians because those who follow Jesus are better than other people in the world. If you would like to take that piece of advice, even from an atheist, and become a follower of Jesus and become a Christian tonight, come.

Primordial Soup

By Daniel Nuckols

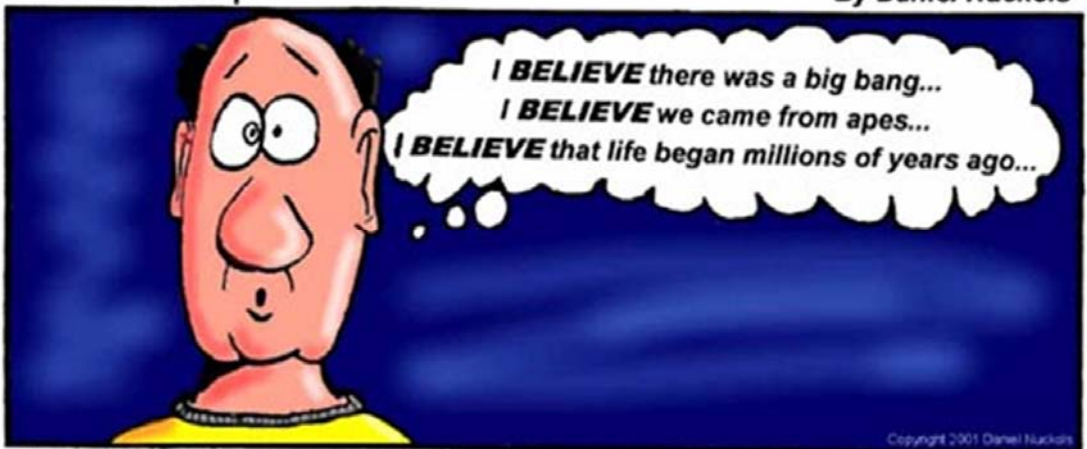

Who said evolution is not a religion?

Copyright © 2001 Daniel Nuckols

DOING OUR BEST

My grandson always does his best. He runs as hard and fast as he can possibly run. Next year he will be two inches taller and will run even faster. I see him as always doing his best.

That is the most encouraging view we can have of other people. We need to see them as always doing their very best. We usually see ourselves as doing the best we can, considering our life experiences. We don't know all the life experiences, struggles, fears and hindrances that another person has, but we can assume that each one is doing their very best.

People thrive when they are accepted as they are and held in high esteem. Our task is to provide support, nurturing, information and encouragement to grow spiritually. As we grow, our best seems to grow. We can do more this year than last.

"I do the very best I know how-the very best I can; and I mean to keep on doing so until the end."
Abraham Lincoln

We accept and love others as they are but always seeing potential for growth. Jesus loves and accepts us as we are and he tells us to accept each other. "Accept one another, then, just as Christ accepted you, in order to bring praise to God." (Rom. 15:7)

Our task is to nurture spiritual growth. We do that by doing our very best to communicate the love and joy of Jesus Christ to others. We inspire a love of God's word and continue our own learning so that we can be a good example for others. Always do the best you can and accept that others are running as fast as they can!

Elizabeth Brown

THE BASIC PREMISE OF THE CHURCHES OF CHRIST IS THAT:

- 1. ALL CHRISTIAN REVELATION WAS GIVEN IN THE FIRST CENTURY, &**
- 2. FIRST CENTURY REVELATION INCLUDES SOME INSTRUCTIONS WHICH ARE NOT OPTIONAL TO IGNORE.**

ANOTHER WAY TO SAY THIS IS "SPEAK WHERE THE BIBLE SPEAKS, AND REMAIN SILENT WHERE THE BIBLE IS SILENT".

ANOTHER WAY TO SAY THIS IS REV. 22: 18-19: ¹⁸ I warn everyone who hears the words of the prophecy of this book: If anyone adds anything to them, God will add to him the plagues described in this book. ¹⁹ And if anyone takes words away from this book of prophecy, God will take away from him his share in the tree of life and in the holy city, which are described in this book.

The old law tells us of the seriousness of God's judgment.

The new law tells of God's expectations of us today.

The church of Christ attempts to follow God's instructions rather than contemporary preferences to be sure you will be pleasing to God on judgment day.

Would you want to be anyplace else?

All we need to do is to effectively communicate that.

Foster's Home for Children

*"More than a home,
A sanctuary."*

Placement applications accepted.
Employment applications welcome.
Applications and donations available
online at
www.fostershome.org
Stephenville, Texas

FAILING A TEST WITH DIGNITY

Joanna works in an office. Her computer is a stand-alone system. What is a stand-alone computer system?

*It doesn't come with
a chair*

DO
YOU
BELIEVE
THE
BIBLE?

The first century church taught the baptism of consenting adults (Acts 2:38)

If your religious group teaches something else, you might like to visit your local Church of Christ.

The Churches of Christ attempt to speak where the Bible Speaks and remain silent where the Bible is silent. (Rev. 22:18-19)

Quotable Quotes

Authority not properly delegated authority is authority lost!

THE CHRISTIAN ARRAY

AN E-MAGAZINE DEDICATED TO SUSTAINED SCRIPTURAL CHURCH GROWTH IN OUR GENERATION

C	1	2	3	4
1				
2				
3				
4				

AREA WIDE ACTIVITIES

7/28-8/2 Jersey Village Preacher Training Camp (Daryl@jvcoc.org or 832-237-7550)

10/8-10/10 Lectureship at Oklahoma Christian University

2nd Tues. Preacher's Luncheon, confirm with Dale Foster at dalefost@gmail.com for address.

December Annual Sacred Harp Singing

5/22/14 Foster's Home For Children Golf Tournament, Blackhorse

Aug 2014 Area Wide Campaign for Christ

YAHOO GROUP

HoustonCofC is a Yahoo group hosted by Steve Sandifer [steve.sandifer@sbcglobal.net] for the purpose of communicating Houston area news among the brethren. It is open to any member of the church at no cost.

The Christian Array Newsletter

This newsletter will be sent to members of the church on a monthly basis as an attempt to promote scriptural teachings, area wide activities and church growth. If you do not want to receive this newsletter, send an e-mail to info@thearray.org and it will be stopped.

E-MAIL ADDRESSES

A goal of this newsletter is to develop a mailing list of as many members of the church as possible and to communicate church related information to as many members as possible. In that light, we would appreciate:

1. Your forwarding the church member e-mail addresses which you have.
2. Sending the directory of the congregation you attend or any other directories which you might have.
3. Give us an idea of how to collect church member e-mail addresses.

The Christian Array is dedicated to support the sustained scriptural growth of the churches of Christ. It is published by BCE Publications, a 501(c)(3) organization with Benton F. Baugh, Ph.D., P.E. as editor BCE is solely responsible for the content. Any announcements, requests for publication, or comments should be e-mailed to info@thearray.org.